

DKL SERIES

Darkfield lights

DKL19.02



















Generally used to illuminate objects from camera axis with a small angle, emphasizing small cracks, lines and reliefs of the piece to be inspected and also eliminating the brightness and shadows. This series of direct light darkfields is specially thought for providing a huge amount of light to highlight edges and possible variations in height when taking photographs.

► Technical specifications¹

Lighting model	DKL1813A	DKL2418A	DKL3223A	DKL4130A	DKL5650B
					
Dimensions	188x188x13	240x240x13	337x337x13	394x394x13	570x570x10
Inner O	130	180	230	300	500
RWD (mm)	<10	<15	<20	<20	<20
Weight	340g	430g	930g	1180g	
IP rating	IP40	IP40	IP40	IP40	IP40
Mounting holes	(x8)∅4x THRU	(x8)∅4x THRU	(x8)∅4x THRU	(x8)∅5x THRU	(x8)∅4.5x THRU
Connection	BN = +24V ±3% BU = 0V	BN = +24V ±3% BU = 0V	BN = +24V ±3% BU = 0V	BN = +24V ±3% BU = 0V	BN = +24V ±3% BU = 0V
Power cable	Pre-cabled with flying leads 2x0.5mm ² Length=1.8m	Pre-cabled with flying leads 2x0.5mm ² Length=1.8m	Pre-cabled with flying leads 2x0.5mm ² Length=1.8m	Pre-cabled with flying leads 2x0.5mm ² Length=1.8m	Pre-cabled with flying leads 2x0.5mm ² Length=1.8m
Modifiers ²	N/A	N/A	N/A	N/A	N/A
Accessories ³					
iBlueDrive tech.	inline	inline	N/A	N/A	inline
iBlueDrive connection	3P aerial male inline connector. L= 715mm. PIN 1 = +24V ±8% PIN 2 = 0V PIN 3 = Control ⁴	3P aerial male inline connector. L= 715mm. PIN 1 = +24V ±8% PIN 2 = 0V PIN 3 = Control ⁴	N/A	N/A	3P aerial male inline connector. L= 715mm. PIN 1 = +24V ±8% PIN 2 = 0V PIN 3 = Control ⁴
iBlueDrive power cable (Not-included)	VCC Series	VCC Series	N/A	N/A	VCC Series
iBlueDrive accessories ³	  	  	N/A	N/A	  

► Instantaneous consumption⁵ (max.)

*WT

Lighting model		DKL1813A	DKL2418A	DKL3223A	DKL4130A	DKL5650B	
TYPE C 24VDC		5W	7.6W	20W	27W	21W	-470C
		5W	7.6W	20W	27W	21W	-525C
		5W	5W	18W	20W	15W	-630C
		2.9W	5.3W	12W	19W	12W	-850C
TYPE P D _{max} = 1/2 Ton max= 60s		6.4W	9.5W	25W	34W	21W	-400P
		6.4W	9.5W	25W	34W	21W	-W00P
TYPE S D _{max} = 1/20 Ton max= 2ms		1320mA/32W	1585mA/38W	5280mA/127W	7040mA/169W	3695mA/89W	-400S
		1320mA/32W	1585mA/38W	5280mA/127W	7040mA/169W	3695mA/89W	-470S
		825mA/20W	990mA/24W	3300mA/79W	4400mA/106W	2310mA/55W	-525S
		880mA/21W	1585mA/38W	3520mA/84W	5630mA/135W	3695mA/89W	-630S
		1045mA/25W	1880mA/45W	4180mA/100W	6690mA/161W	4390mA/105W	-850S
		1320mA/32W	1585mA/38W	5280mA/127W	5630mA/135W	880mA/21W	-W00S
TYPE i ⁶ 		6.2W[29W/3.4W]	9.1W[44W/4.8W]	N/A	N/A	21W[96W/11W]	-400i
		5.7W[29W/3.9W]	8.3W[44W/5.7W]	N/A	N/A	19W[96W/13W]	-470i
		4.8W[15W/2.8W]	7W[22W/3.9W]	N/A	N/A	16W[96W/8.5W]	-525i
		9.1W[29W/6.2W]	13W[44W/9.1W]	N/A	N/A	31W[96W/21W]	-630i
		8.4W[29W/4.8W]	12W[44W/7.0W]	N/A	N/A	28W[96W/16W]	-850i
		6.2W[29W/3.4W]	9.1W[44W/4.8W]	N/A	N/A	21W[96W/11W]	-W00i

N/A= Not available CUS = Custom

(1) Environmental specifications and iconography legend in additional annex Z1.4 and Z2 respectively.

(2) Prior to manufacturing optional modifications in standard lighting systems. Please, consult the code before ordering (additional annex Z2.1).

(3) Accessories are not-included. More information in accessories section.

(4) iBlueDrive control input wiring specifications in additional annex Z1.2.

(5) Bear in mind that consumption table is only to be used as a guide. To refer to real values, please, consult product label when purchasing.

(6) Values of maximum instantaneous consumption of 'Type i' lighting systems in Powered mode [Strobe mode / Continuous mode]



DKL SERIES

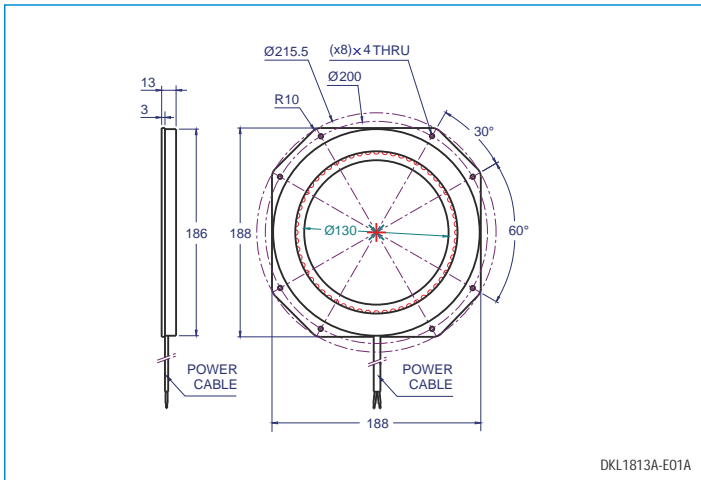

DKL1813A-E01A

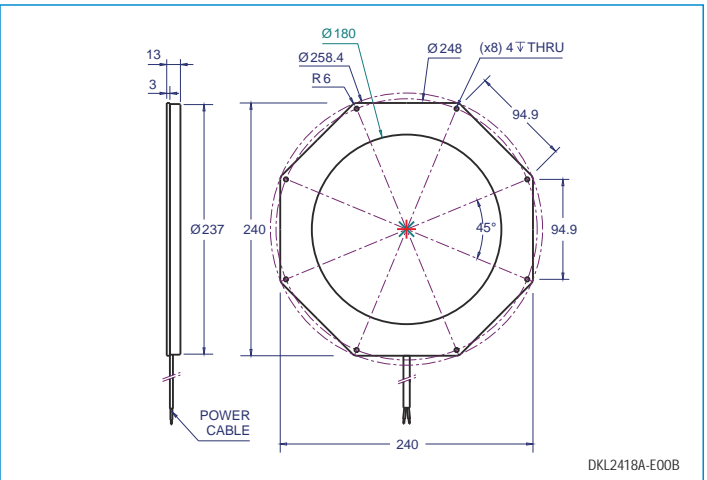

DKL2418A-E00B

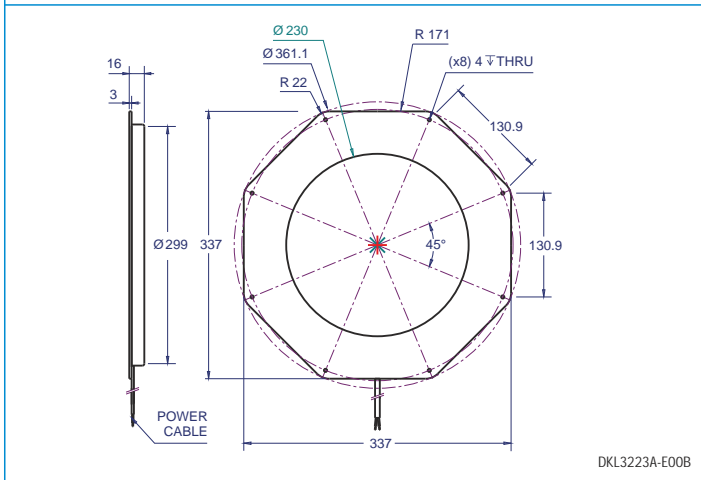

DKL3223A-E00B

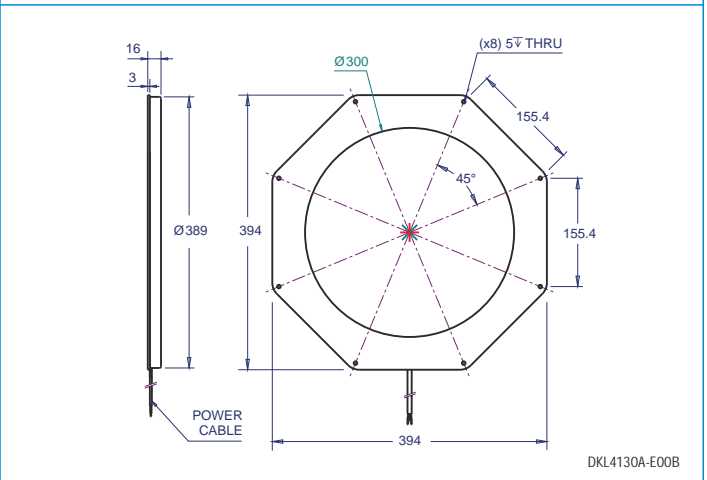

DKL4130A-E00B

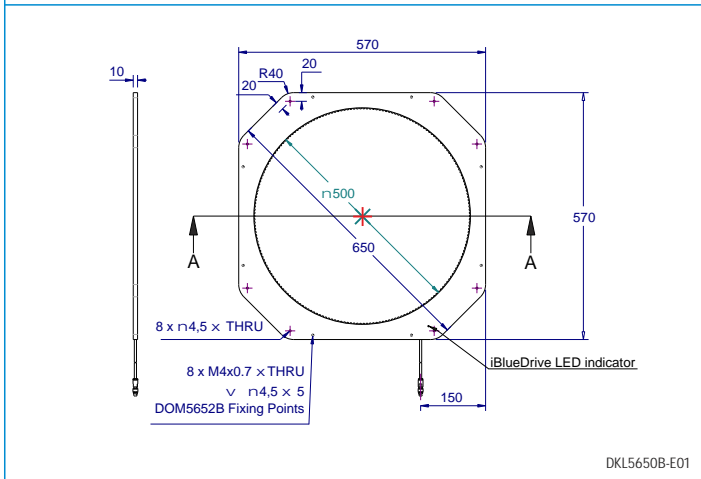

DKL5650B-E01

All units in millimeters, if not indicated.



Example of DKL captured image



► Z1.2 - iBlueDrive control input wiring

All iBlueDrive products come together with a quick-start guide for connection and working conditions. Refer to iBlueDrive Manual for extended information.

NPN wiring for strobe or ON/OFF mode

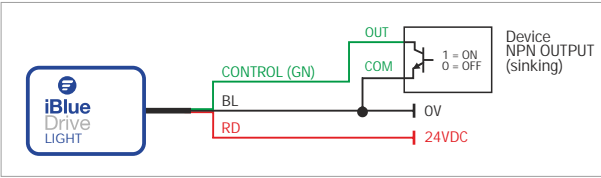

PNP wiring for strobe or ON/OFF mode

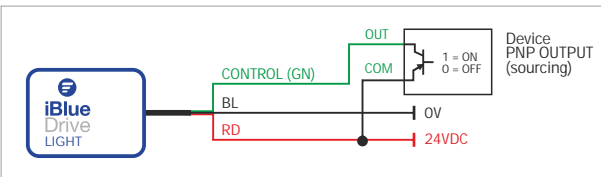

TTL wiring for strobe or ON/OFF mode

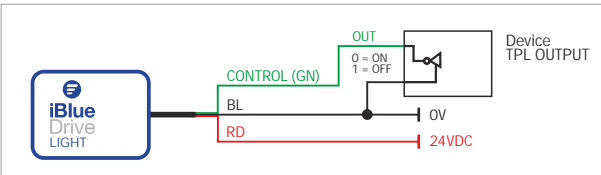

Wiring for continuous mode

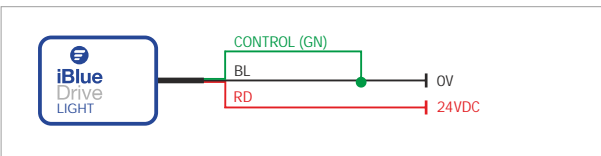

► Z1.3 - iBlueDrive inline

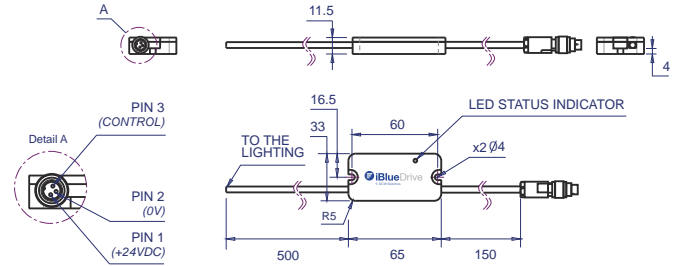

iBlueDrive inline is the driver for iBlueDrive technology integrated as a box of 65x33mm to the cable that goes from the lighting system to the connector. It is used when iBlueDrive driver can not be integrated on chassis. See diagram:

















WARNING! In continuous and powered mode, clamp driver to a metal surface for heat dissipation. In Strobe mode is not required, but recommended.















► Z1.4 - Environmental Specifications

Max. Operating Humidity	85% non-condensing
Operating Temperature	0 - 40°C
Storage Temperature	0 - 60°C
Housing material	Anodized aluminium
Standards	  



► Z2.1 - Modifiers legend

icon	Description	Code
	Narrow angle of emission	/AN
	Medium angle of emission (By default)	/AM
	Wide angle of emission	/AW
	Oval angle of emission = 23-24° (x) 17-18° (y)	/AO
	Diffuse emission	/AD
	Polarizer filter	/FPL
	Diffuser filter	/FDR
	Dome hole of 46mm	/CC1
	Dome hole of 40mm	/CC2
	IP Rating = IP67	/67
	PNP input model	/P
	50mm focal Length	/F1
	150mm focal Length	/F2
	Infinite focal Length	/F3





► Z2.2 - Accessories legend

icon	Description	Serie
	Power cable/s	VCB, VCC, VCD Series
	Other cable/s	VCU, VCL
	Strobe and RGB controller/s	VST, VSC Series
	Polarizer filter	VPF, VPC
	Diffuser filter	VDF
	Collimater filter on x axis	VCFx
	Collimater filter on y axis	VCFy
	Collimater filter on xy axis	VCFxy
	Darkfield converter	VRF
	Protector filter	VPT
	Heat dissipator	VHD
	Fixing bracket	VBA, VBB, VBC Series

► Z2.3 - iBlueDrive Accessories legend

icon	Description	Serie/Product
	Accessorie to configure iBlueDrive devices: iBlueDrive Box, iBlueDrive USB	VTA0005A, VTA0006A, VTA0007A
	iBlueDrive optocoupler	VTA0020A
	iBlueDrive potentiometer	VTA0030B







► Z2.4 - Technical drawings legend

icon	Description
	Optical axis
	Viewing window dimensions
	Lighting elements
	Light emission center
	Lighting surface dimensions



► Z2.5 - Colours & Wavelegths legend

icon	Wavelength	Colour	Code
	365nm	UV-	-365
	400nm	UV	-400
	470nm	BLUE	-470
	525nm	GREEN	-525
	630nm	RED	-630
	850nm/880nm	IR	-850/-880
		WHITE	-W00
		RGB	-RGB

► Z2.6 - Types of lighting legend

icon	Description
	Radial lighting
	'Darkfield' lighting effect. Low angle illumination
	Backlight illumination
	'Cloudy day' lighting effect
	'Bright field' lighting effect
	Projector lighting
	Axial lighting

► Z2.7 - Types of light legend

icon	Description
	Direct light
	Diffuse light
	Ultra-diffuse light